

SPRT®

POS Thermal Receipt Printer

(SP-POS891)

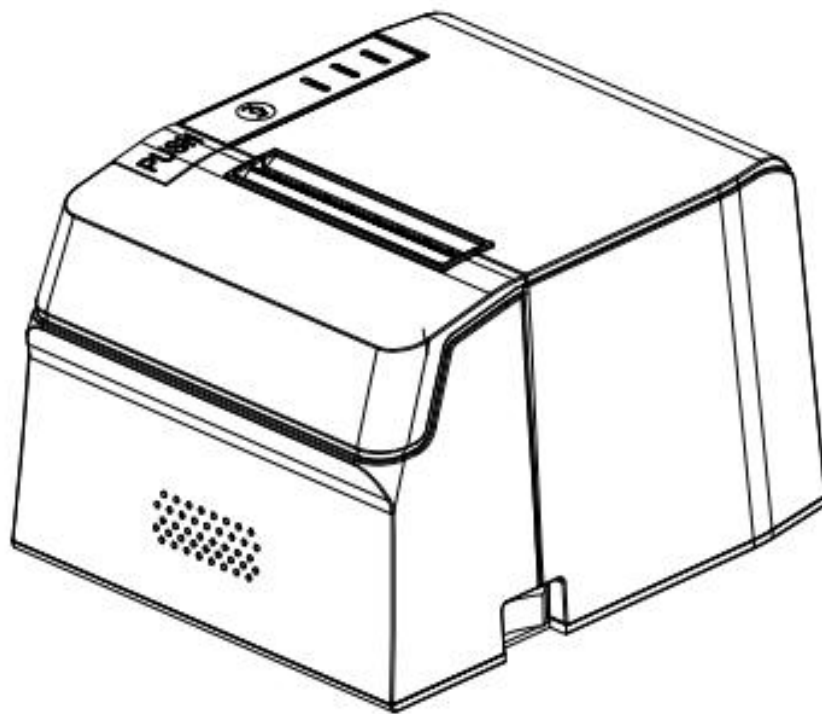

User's Manual

(Ver 1.05)

Beijing Spirit Technology Development Co.,Ltd.

www.sprt-printer.com

Content

Introduction.....	1
Chapter 1 Feature and Performance.....	1
1.1 Print Performance.....	1
1.2 Print Paper.....	2
1.3 Print Font.....	2
1.4 Interface.....	2
1.5 Print Control Commands.....	3
1.6 Power Supply.....	3
1.7 Operation Environment.....	3
1.8 Outline Dimension.....	3
1.9 Model classification.....	4
Chapter 2 Operation Specification.....	4
2.1 Printer Appearance.....	4
2.2 Paper Installation.....	5
2.2.1 Paper Loading.....	5
2.2.2 Solution to Paper Jam.....	5
2.3 Interface.....	6
2.3.1 Serial Interface.....	6
2.3.2 Ethernet Interface.....	7
2.3.3 USB Interface.....	7
2.3.4 Cash Drawer Interface.....	7
2.3.5 Power Connection.....	8
2.4 Buttons and Indicators.....	8
2.5 Power on status.....	11
2.6 Self-test.....	11
2.7 Hexadecimal Printing.....	12
2.8 Parameter Setting.....	13
2.9 Enter the program upgrade mode.....	13
Appendix A.....	14

Introduction

POS891 printer is a new type line thermal printer, it features in fast speed print, low print noise, high reliability, perfect print quality and ribbon needless, avoiding the vexation of regular maintenance.

POS891 printer: small in outline dimension, simple operation, and extensive application, especially suitable for commercial cash register, PC-POS, bank POS and all kinds of receipts print.

Warning

This is a class A product. In a domestic environment this product may cause radio interference in which case the user may be required to take adequate measures.

Chapter 1 Feature and Performance

1.1 Print Performance

- Print method: direct thermal
- Print paper width: 79.5±0.5mm
- Print density: 8 dots/mm, 576 dots/line
- Print speed: Max 220mm/s
- Reliability
 - (1)Print Head Life:150km
 - Using condition:
 - * Print 12 × 24 ASCII characters, print 50 lines each time, intermittent print repeatedly
 - * Use specified thermal paper
 - (2)Cutter Life: 1500,000 cuts

- Valid print width: 72mm

1.2 Print Paper

- Thermal paper roll model: TF50KS—E (Japan paper co.ltd)
AF50KS-E (JUJO THERMAL)
- Thermal paper roll: Paper Type— — Thermal Paper 79.5 x ϕ 80mm (max)
Inner Diameter— — — 13mm (min.)
Thickness — — — 0.06mm~0.08mm

1.3 Print Font

- ANK Character Set
12×24 dots, 1.5 (W) × 3.00 (H) mm
- GB GB2312-80(Chinese):
24×24 dots, 3.00 (W) × 3.00 (H) mm.

1.4 Interface

- RS—232C Serial Interface:
DB-9 socket (female), supports XON/XOFF and DTR/DSR protocols.
Baud rate: 1200, 2400, 4800, 9600, 19200, 38400, 57600, 115200bps
adjustable.
Data structure: 1start bit + (7 or 8) data bits + 1 stop bit.
Parity checking: no parity or odd/even parity optional.
- Ethernet Interface:
Standard Ethernet interface.
- USB Interface:

Standard USB interface

- Cash Drawer Control

DC24V, 1A, 6-pin RJ-11 socket.

1.5 Print Control Commands

- Character print commands: support double-width, double height print of ANK characters, user-defined characters and Chinese characters, the character line spacing is adjustable.
- Graphics print commands: support the print of bit-map graphics and download bit-map graphics with different density
- GS bar code print commands:
support UPC-A, UPC-E, EAN-13, EAN-8, CODE39, ITF25, CODEBAR, CODE93, CODE128, PDF417, QR code, DATA Matrix code print.

1.6 Power Supply

- DC24V \pm 10%, 1.5A, A-1009-3P power socket

1.7 Operation Environment

- Operation temperature: 0~50°C; Relative humidity: 10~80%
- Storage temperature: -20~60°C; Relative humidity: 10~90%

1.8 Outline Dimension

- 179(L)mm \times 152(W) mm \times 118 (H)mm

1.9 Model classification

Model	Interface	Print speed (Max)
-------	-----------	-------------------

SP-POS891U	USB	220mm/s
SP-POS891US	RS-232C、USB	
SP-POS891E	100M Ethernet	
SP-POS891USd	RS-232C、USB	200mm/s
SP-POS891UEd	USB、100M Ethernet	
SP-POS891Udn	USB	
SP-POS891UEdn	USB、100M Ethernet	

Chapter 2 Operation Specification

2.1 Printer Appearance

Printer part name diagram:

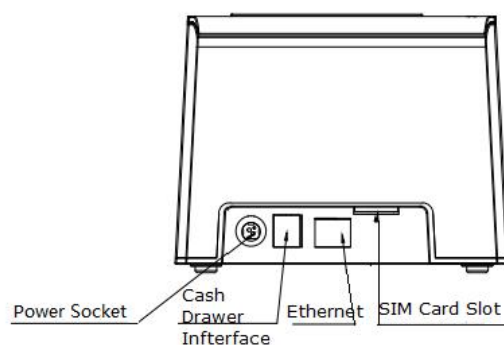
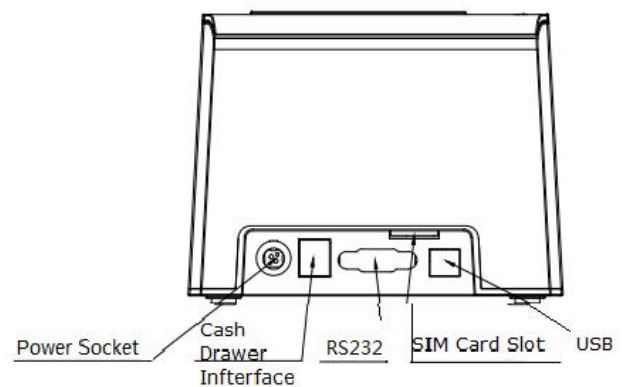
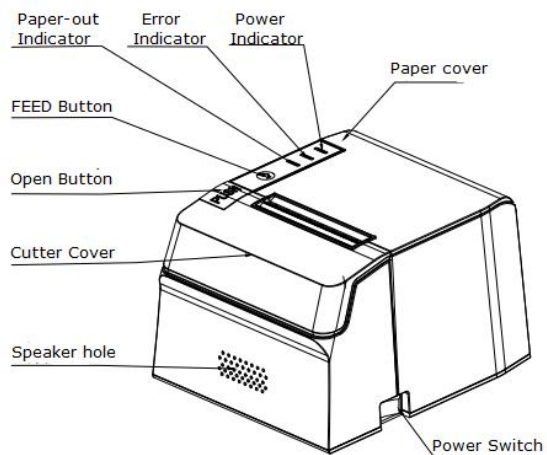

Figure 2-1 Printer Part Name Diagram

2.2 Paper Installation

2.2.1 Paper Loading

POS891 adopts 79.5mm±0.5mm width thermal paper roll.

Steps of Loading Thermal Paper are as below:

Hold down the upper cover button on the left side, open the movable upper cover, draw a certain length of the paper roll, put the paper end on the print head, close the upper cover and press it downwards lightly.



- 1. Pay attention to the direction of loading paper, make the printing surface face to the print head.**
- 2. Please don't feed or draw the paper forwards or backwards with hands.**
- 3. Keep clean of the print head, avoid to influence the printing quality.**

2.2.2 Solution to Paper Jam

If cutter jam, turn off the power, and turn on again, the cutter will be back to original position. If paper jam, open the paper storage cover, and take out the paper. If the cutter can not be back to the original position, open the cover of it, and turn the white plastic gear by the direction suggestive on the cutter by hand to make the cutter be back to the original position.

If cutter jam, but hope no loss of data in printer, don't turn off the power. Get the cutter back to the original position by the above mentioned method by hand. Then

open the paper cover and take out the paper, close the paper cover. The printer will recover automatically from Cutting Error.

2.3 Interface

2.3.1 Serial Interface

The serial interface of SP-POS891 printer is compatible with RS-232C, supports DTR/DSR and XON/XOFF handshaking protocols, uses DB9 socket (female). The pin order of the serial port is as Fig.2-2 shows:

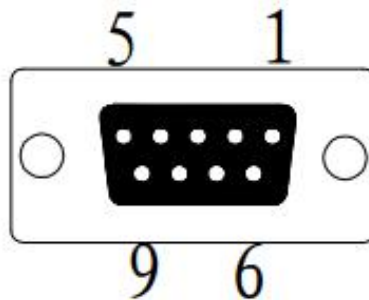

Pin No.	Signal Name	Source	Description
2	TXD	Printer	Printer transmits control code X-ON/X-OFF and data to host
3	RXD	Host	Printer receives data from host
6	DSR	Printer	Same with CTS
8	CTS	Printer	Signal "MARK" means the host is busy and can not receive data. Signal "SPACE" means the printer is ready to receive data.
5	GND	—	Signal Ground

2.3.2 Ethernet Interface

The model with Ethernet interface use RJ45 Network socket. The appearance is as Fig.2-3 shows:

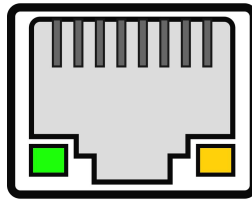

Fig2-3 Ethernet Interface

2.3.3 USB Interface

The standard accessories of POS891 printer includes a Mini USB cable with D Type connector which connects printer and main device. The USB type belongs to the slave device type (DEVICE). Pins description of Mini-USB as Fig.2-3 below:



Fig.2-4 USB interface

Pin	Function	Notes
1	V Bus	Power +5V
2	Data-	Data-
3	Data+	Data+
4	GND	Ground

2.3.4 Cash Drawer Interface

The cash drawer interface of POS891 adopts RJ-11 6-pin socket, as Fig.2-5 shows:

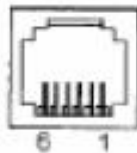

Fig.2-5 Cash Drawer Interface

The pin assignment is as below:

Pin No.	Signal	Direction
1	Chassis Ground	—

2	Cash drawer driver signal 1	Out
3	Cash drawer on/off status signal	In
4	+24VDC	—
5	Cash drawer driver signal 2	Out
6	Signal ground	—

2.3.5 Power Connection

POS891 uses the external power supply adopter as 24V±10%,1.5A, power socket is A-1009-3P model, as Fig. 2-5 shows:

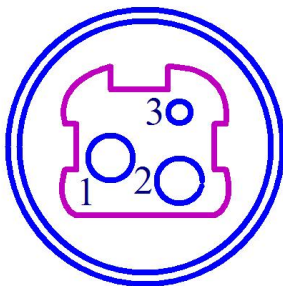

The pin assignment is as below:

Pin No.	Signal
1	+24VDC
2	Ground
3	NC

Fig.2-6 Definition of power socket and pin

2.4 Buzzer, Buttons and Indicators

There is one button and one inner buzzers and three indicators on POS891 printer.

【FEED】 is paper feeding button, the function of its enabling or disabling the button on/off can be set by print command, when the button is enabled, press 【FEED】 button, then the paper presenting driver starts up and paper fed into the printer; release 【FEED】 button, paper feeding stops.

The buzzer indicates the error status type, which can be set to enabling error alarm or disabling by parameter setting. Error status type is the same as error indicator.

The green POWER indicator is the power indicator. The POWER indicator lights, it indicate that the printer is turned on.

The red indicator is the paper status indicator. The indicator light indicates that the printer is out of paper.

Red/Blue indicator is ERROR/ALARM indicator, the red indicator is dark when printer work normally; and alarm abnormal status of printer while it flashes. When it is on for a long time, it means paper case opened in the printing process. The blue indicator flashes reminds that printer has received document.

When the document received indicator flash, the buzzer rings for three times, it reminds that printer has received document.







When the error indicator flashes and the buzzer rings, it means there is an error in the printer.

According to the different flicker type, the different error types are as below:

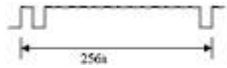
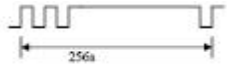
1. Non-recoverable error, the times of indicator flickering and buzzer sounding mean the error type, then persistent lighting.
2. Recoverable error, the times of indicator flickering and buzzer sounding mean the error type, then persistent indicator-off.
3. Auto-recoverable error, the indicator flickers and the buzzer sounds persistently.
4. Paper out, PAPER OUT indicator lights and the buzzer sounds persistently. When the paper case cover is open, whether the paper is out or not will not be tested, but just testing whether there is paper in printer.

The details are as below:

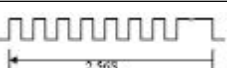
①.. Non-recoverable error, the indicator flickers several times, then persistent lighting. The times of flickering means the error type,

ERROR Type	ERROR Description	ERROR Indicator Flickering Type
Non-recoverable error	LED Flickers once: Internal memory reading and writing error	
	LED Flickers twice: over-voltage	
	LED Flickers three times: under-voltage	
	LED Flickers four times: CPU execution error (wrong address)	
	LED Flickers five times: UIB error	
	LED Flickers six times: FLASH writing error	
	LED Flickers seven times: parameter writing error	
	LED Flickers eight times: Temperature testing circuit error	

②. Recoverable error, indicator flickers constantly, then persistent off for one period.

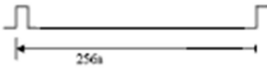
ERROR Type	ERROR Description	ERROR Indicator Flickering Type
Recoverable error	LED Flickers once: Cutter position error	

③. Auto-recoverable error, indicator flickers constantly, including printing head over-heat error and upper case cover opening error during printing.

ERROR Type	ERROR Description	ERROR Indicator Flickering Type
Auto-recoverable error	LED Flickers constantly: printing head over-heat; upper case cover opening error during printing	

2.5 Power on status

Paper cover close when power off. Press the power button, the error indicator and

paper out indicator flash twice alternately and out, then printer will be on the normal working mode.

2.6 Self-test

The self-test will check the condition of printer, if the printer prints out the self-test receipt correctly, it means the printer works normally, except interface with host. Otherwise it needs to repair.

The self-test will print out the name of manufacturer, printer type, software version, interface type and printer defaulted parameter, 96 characters in ASCII and defaulted Code page content(the language is English) or the name of Chinese characters library(if the language is Chinese) and Bar code type.

Way of self-test: hold down **【FEED】** button and turn on the power, self-test begins automatically at this moment. Different model of the printer have a little different parameters on self-test. SP-POS891US model printer self-test as Fig.2-7 shows

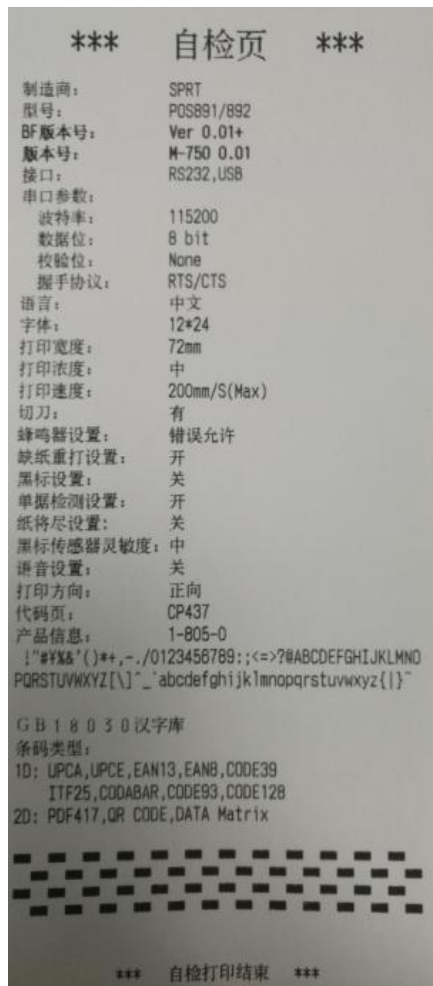

Fig.2-7

2.7 Hexadecimal Printing

Turn on the printer according to the step below, it will enter the mode of Hexadecimal Printing

1. Open the cover;
2. Hold down **【FEED】** button, and connect with power; wait for the alarm and close the paper cover.
3. The printer will print out 3 lines as below:

Hexadecimal Dump

To terminate hexadecimal dump,

Press FEED button three times.

This means the printer has entered hexadecimal printing mode, and under this mode, all of the input will be printed out as hexadecimal number, feed one line with

single-click of “FEED” button, after 3 times, it will print out “*** Completed ***”, and exit hexadecimal printing mode.

2.8 Parameter Setting

There are two ways to set printer parameters:

1. Use the setting tool on the PC side for setting.
2. Set by the button, the specific operation method is as follows.

When printer power is off, open paper case cover firstly. Hold the【FEED】button, then switch on the printer and release the【FEED】when the status indicator and paper-out indicator flash alternately. Then press the 【FEED】twice and close the paper cover, printer enter the setting mode and print out the first set parameter and its default value. The details method of setting parameter can refer to Appendix A.

Steps for exiting of parameter setup:

Open paper case cover and press the 【FEED】 button; then close paper case cover and release the 【FEED】 button. The printer will save the setup of parameters, exit setting mode and enter the normal working mode.

The data will not be saved if turn off the printer directly.

Note: SP-POS891USd/SP-POS891Udn not support button settings .

2.9 Enter the program upgrade mode

When printer is power off,open paper case cover. Hold the 【FEED】 button, then switch on the printer and release the【FEED】when the status indicator and paper-out indicator flash alternately. Then press the 【FEED】 for five times (RS232 and USB interface support, Ethernet adopts the web page mode to upgrade directly) and close the paper cover, printer enter the program upgrade mode. At this time, the status indicator flash once a second.

Quick enter method:

Open the paper case cover firstly when printer is power off. Hold the 【FEED】 button and switch on the printer, then release the 【FEED】 button quickly, then printer enter the program upgrade mode. At this time, the status indicator flash once a second.

Notice:

1. When printer enter the program upgrade mode, the paper-out indicator flash means the interface can't be upgraded.
2. SP-POS891USd only supports USB interface upgrade mode.

Appendix A

This appendix is the method to set the printer parameter according to button operation.

Setting introduction: Press 【Paper cover】 button to choose setting, when press it once, the set become the next one and it will print the present set value; use 【FEED】 button to set the set value, when press it once, the set become the next one and it will print the present set value.

General Setting:

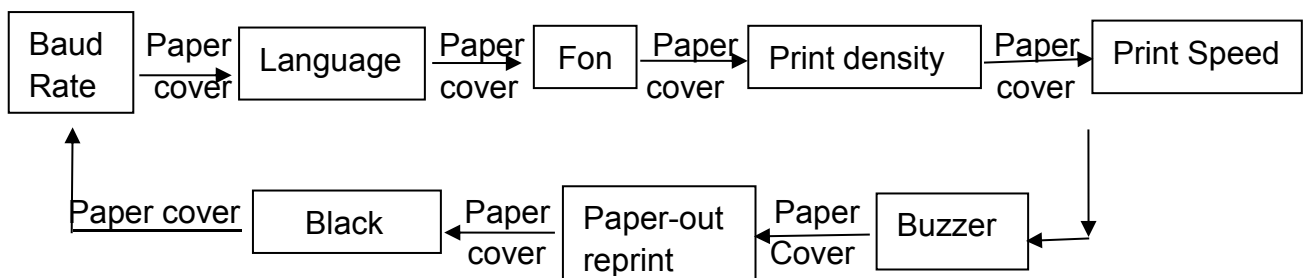

Baud rate:

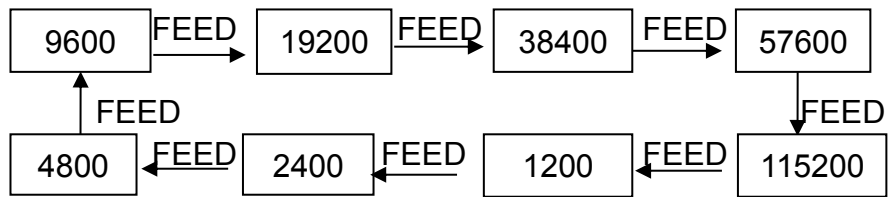

Language:



Font:

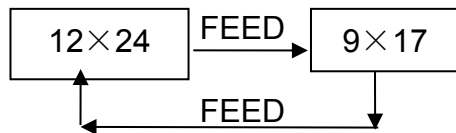

Print density:

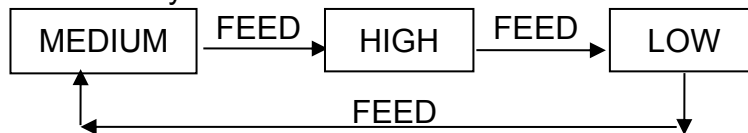

Print speed:

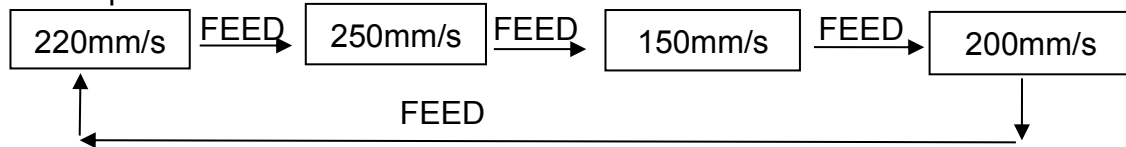

Buzzer:

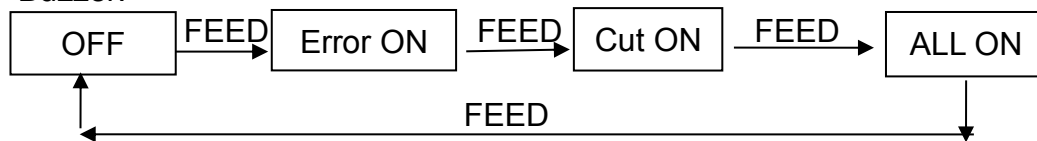

Paper-out reprint:

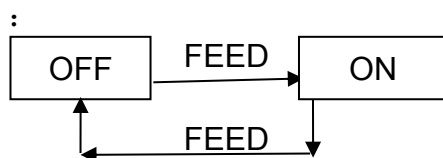

Black mark mode:.

